

ASANSÖR MARKET
ELEVATOR MARKET



ÜRÜN KATALOĞU
PRODUCT CATALOGUE

Hakkımızda

BİZİM LİFT ASANSÖR, 30 yıllık üretim tecrübesi ile üretimin her aşamada kalite kontrol süreci işletilerek yapılmaktadır. Deneyimli yönetimi, teknik kadrosu ve ileri teknolojiye sahip makine parkuru ile yurt içi ve yurt dışı müşterilerine hizmet veren firmamız, kalite anlayışını koşulsuz müşteri memnuniyeti olarak belirlemiştir. **BİZİM LİFT** Asansör kaliteli hizmet verme hedefinin başında müşteri memnuniyeti olduğunu prensip edinmiştir. Müşterilerine daima kesintisiz ve kaliteli hizmet verebilmek için, teknik kadrosuna ilave olarak müşteri temsilcileri tayin etmiştir. Bu temsilciler sayesinde müşterilerimiz kullandıkları asansör parçaları hakkında daha fazla bilgi edinmişlerdir.

About Us

*As BİZİM LİFT ELEVATOR, with our 30 years of production experience, we produce elevators with quality control at every stage. We provide services to domestic and abroad customers with our experienced management, technical staff and high-tech machinery to accomplish all that, we have defined our quality understanding as the unconditional customer satisfaction. As, **BİZİM LİFT** Elevator we have adopted customer satisfaction as our main principle for our goal of providing quality service. We have appointed customer representatives in addition to our technical staff in order to always provide our customers with continuous and quality service. Thanks to these representatives, our customers are able to learn more about the elevator parts that they use.*

İÇİNDEKİLER / TABLE OF CONTENTS

Kabin Seçenekleri	<i>Cabin Options</i>	06-27
Kabin Seçenekleri (Panoramik)	<i>Cabin Options (Panoramic)</i>	28-29
Kabin Seçenekleri (Yük)	<i>Cabin Options (Load)</i>	30-31
Kabin Seçenekleri (Cam)	<i>Cabin Options (Glass)</i>	32-33
Tavan Çeşitleri	<i>Ceiling Options</i>	34-35
Paslanmazlar	<i>Stainless</i>	36
Laminat Seçenekleri	<i>Laminate Options</i>	37
Küpeştelere	<i>Handrail</i>	38
Zeminler	<i>Floors</i>	39
Ray Bağlantı Konsolları	<i>Rail Connection Guides</i>	40-43
Ray Bağlantı Ekipmanları	<i>Rail Connection Equipment</i>	44-45
Makine Şasesi	<i>Machine Chassis</i>	46-47
Asansör Ekipmanları	<i>Elevator Equipment</i>	48-57
Makine Motor	<i>Machine Engine</i>	58-59
Kablo Durumu	<i>Cable Status</i>	60
Hidrolik Asansör	<i>Hydraulic Elevator</i>	61
Otomatik / Manuel Kapılar	<i>Automatic / Manual Doors</i>	62-65
Ray Grubu	<i>Rail Group</i>	66-67
Kumanda Panosu	<i>Control Panel</i>	68-69
İş Ortaklarımız	<i>Our Business Partners</i>	70



B

İZİM LİFT

M

ARKET



KABİN SEÇENEKLERİ / CABIN OPTIONS

▪ Kaplama	Cam (Desen Baskılı)
▪ Aksesuar	Ayna Paslanmaz
▪ Tavan	Lazer
▪ Taban	Cam
▪ Ayna Şekli	Tam Boy
▪ Küpeşte	Ayna Paslanmaz



BZM 1001

▪ Cladding	Glass (Patern Printed)
▪ Accesory	Stainless Mirror
▪ Ceiling	Laser
▪ Base	Mirror
▪ Mirror Type	Full-length
▪ Railing	Stainless Mirror





▪ Kaplama	Cam (Desen Baskılı)
▪ Aksesuar	Ayna Paslanmaz
▪ Tavan	Lazer
▪ Taban	Cam
▪ Ayna Şekli	Tam Boy
▪ Küpeşte	Ayna Paslanmaz



BZM 1002

▪ Cladding	Glass (Patern Printed)
▪ Accesory	Stainless Mirror
▪ Ceiling	Laser
▪ Base	Mirror
▪ Mirror Type	Full-length
▪ Railing	Stainless Mirror



KABİN SEÇENEKLERİ / CABIN OPTIONS

▪ Kaplama	Cam (Ral Color)
▪ Aksesuar	Ayna Paslanmaz
▪ Tavan	Lazer
▪ Taban	Özel PVC
▪ Ayna Şekli	Tam Boy
▪ Küpeşte	Ayna Paslanmaz



BZM 1003

▪ Cladding	Glass (Ral Color)
▪ Accesory	Stainless Mirror
▪ Ceiling	Laser
▪ Base	Special PVC
▪ Mirror Type	Full-length
▪ Railing	Stainless Mirror





▪ Kaplama	Cam (Ral Color)
▪ Aksesuar	Ayna Paslanmaz
▪ Tavan	Lazer
▪ Taban	Özel PVC
▪ Ayna Şekli	Tam Boy
▪ Küpeşte	Ayna Paslanmaz



BZM 1004

▪ Cladding	Glass (Ral Color)
▪ Accesory	Stainless Mirror
▪ Ceiling	Laser
▪ Base	Special PVC
▪ Mirror Type	Full-body
▪ Railing	Stainless Mirror



KABİN SEÇENEKLERİ / CABIN OPTIONS

▪ Kaplama	Cam
▪ Aksesuar	Gold Ayna Paslanmaz
▪ Tavan	Lazer
▪ Taban	Özel PVC
▪ Ayna Şekli	Tam Boy
▪ Küpeşte	Ayna Paslanmaz



BZM 1005

▪ Cladding	Glass
▪ Accesory	Gold Stainless Mirror
▪ Ceiling	Laser
▪ Base	Special PVC
▪ Mirror Type	Full-length
▪ Railing	Stainless Mirror





▪ Kaplama	Ahşap
▪ Aksesuar	Altın Ayna Paslanmaz
▪ Tavan	Lazer
▪ Taban	Özel PVC
▪ Ayna Şekli	Tam Boy
▪ Küpeşte	Altın Ayna Paslanmaz



BZM 2001

▪ Cladding	Wood
▪ Accesory	Gold Stainless Mirror
▪ Ceiling	Laser
▪ Base	Special PVC
▪ Mirror Type	Full-length
▪ Railing	Gold Stainless Mirror



▪ Kaplama	Ahşap
▪ Aksesuar	Ayna Paslanmaz
▪ Tavan	Lazer
▪ Taban	Özel PVC
▪ Ayna Şekli	Tam Boy
▪ Küpeşte	Ayna Paslanmaz



BZM 2002

▪ Cladding	Wood
▪ Accesory	Stainless Mirror
▪ Ceiling	Laser
▪ Base	Special PVC
▪ Mirror Type	Full-length
▪ Railing	Stainless Mirror





▪ Kaplama	Ahşap
▪ Aksesuar	Ayna Paslanmaz
▪ Tavan	Lazer
▪ Taban	Özel PVC
▪ Ayna Şekli	Tam Boy
▪ Küpeşte	Ayna Paslanmaz



BZM 2003

▪ Cladding	Wood
▪ Accesory	Stainless Mirror
▪ Ceiling	Laser
▪ Base	Special PVC
▪ Mirror Type	Full-length
▪ Railing	Stainless Mirror



▪ Kaplama	Ahşap
▪ Aksesuar	Ayna Paslanmaz
▪ Tavan	Lazer
▪ Taban	Özel PVC
▪ Ayna Şekli	Tam Boy
▪ Küpeşte	Ayna Paslanmaz



BZM 2004

▪ Cladding	Wood
▪ Accesory	Stainless Mirror
▪ Ceiling	Laser
▪ Base	Special PVC
▪ Mirror Type	Full-length
▪ Railing	Stainless Mirror





▪ Kaplama	Ahşap
▪ Aksesuar	Ayna Paslanmaz
▪ Tavan	Lazer
▪ Taban	Özel PVC
▪ Ayna Şekli	Yarım Boy
▪ Küpeşte	Ayna Paslanmaz



BZM 2005

▪ Cladding	Wood
▪ Accesory	Stainless Mirror
▪ Ceiling	Laser
▪ Base	Special PVC
▪ Mirror Type	Half-length
▪ Railing	Stainless Mirror



- | | |
|--------------|----------------|
| ▪ Kaplama | Ahşap |
| ▪ Aksesuar | Ayna Paslanmaz |
| ▪ Tavan | Lazer |
| ▪ Taban | Özel PVC |
| ▪ Ayna Şekli | Tam Boy |
| ▪ Küpeşte | Ayna Paslanmaz |



BZM 2006

- | | |
|---------------|------------------|
| ▪ Cladding | Wood |
| ▪ Accesory | Stainless Mirror |
| ▪ Ceiling | Laser |
| ▪ Base | Special PVC |
| ▪ Mirror Type | Full-length |
| ▪ Railing | Stainless Mirror |





▪ Kaplama	Ahşap
▪ Aksesuar	Ayna Paslanmaz
▪ Tavan	Lazer
▪ Taban	Özel PVC
▪ Ayna Şekli	Tam Boy
▪ Küpeşte	Ayna Paslanmaz



BZM 2007

▪ Cladding	Wood
▪ Accesory	Stainless Mirror
▪ Ceiling	Laser
▪ Base	Special PVC
▪ Mirror Type	Full-length
▪ Railing	Stainless Mirror



▪ Kaplama	Ahşap
▪ Aksesuar	Ayna Paslanmaz
▪ Tavan	Lazer
▪ Taban	Özel PVC
▪ Ayna Şekli	Yarım Boy
▪ Küpeşte	Ayna Paslanmaz



BZM 3001

▪ Cladding	Wood
▪ Accesory	Stainless Mirror
▪ Ceiling	Laser
▪ Base	Special PVC
▪ Mirror Type	Half-length
▪ Railing	Stainless Mirror

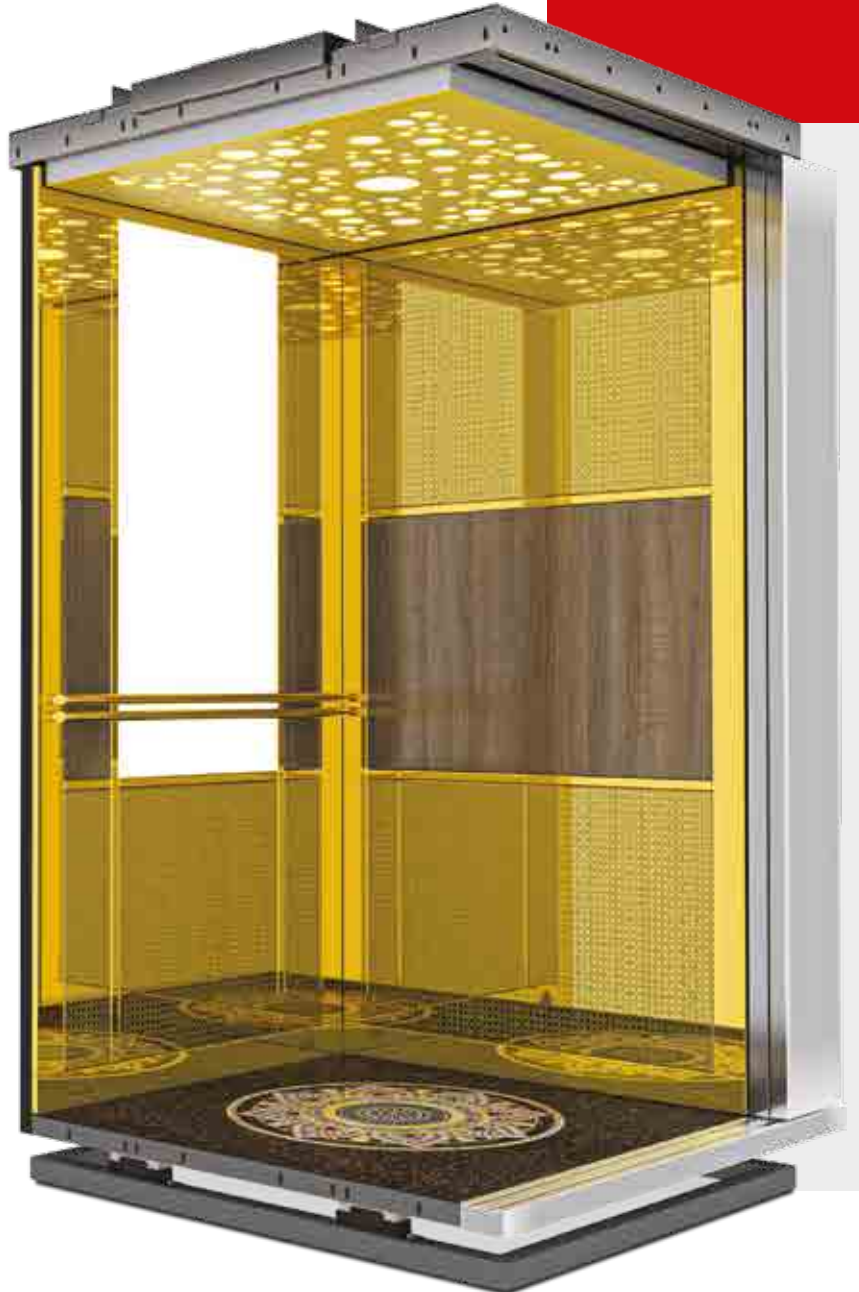



▪ Kaplama	Doğal Taş kaplam
▪ Aksesuar	Gold Ayna Paslanmaz
▪ Tavan	Lazer
▪ Taban	Özel PVC
▪ Ayna Şekli	Yarım Boy
▪ Küpeşte	Gold Ayna Paslanmaz



BZM 3002

▪ Cladding	Natural Stone Coating
▪ Accesory	Gold Stainless Mirror
▪ Ceiling	Laser
▪ Base	Special PVC
▪ Mirror Type	Half-length
▪ Railing	Gold Stainless Mirror

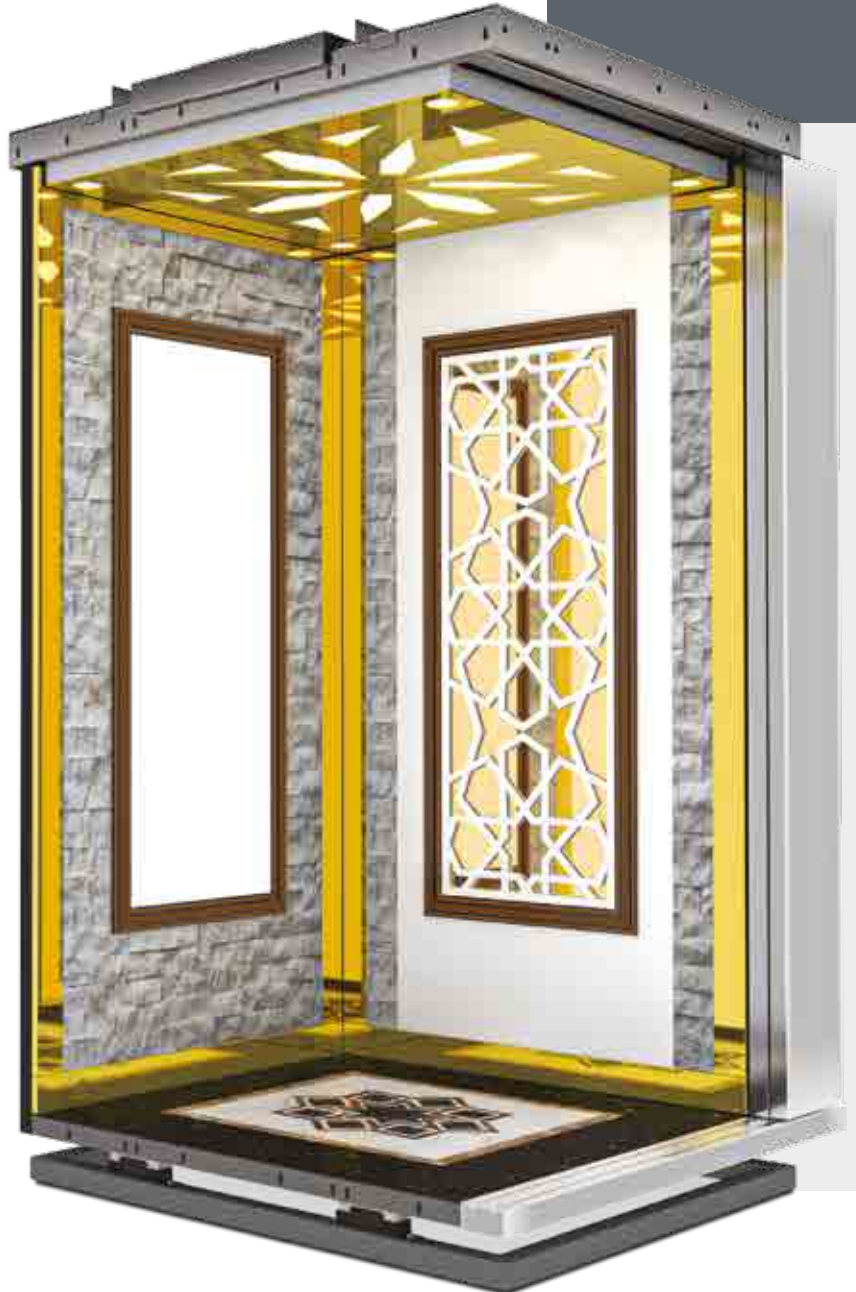

KABİN SEÇENEKLERİ / CABIN OPTIONS

▪ Kaplama	Desenli Paslanmaz
▪ Aksesuar	Gold Ayna Paslanmaz
▪ Tavan	Lazer
▪ Taban	Özel PVC
▪ Ayna Şekli	Tam Boy
▪ Küpeşte	Ayna Paslanmaz



BZM 3003

▪ Cladding	Patterned Stainless
▪ Accesory	Gold Stainless Mirror
▪ Ceiling	Laser
▪ Base	Special PVC
▪ Mirror Type	Full-length
▪ Railing	Stainless Mirror





▪ Kaplama	Cam + Paslanmaz
▪ Aksesuar	Gold Paslanmaz
▪ Tavan	Lazer
▪ Taban	Özel PVC
▪ Ayna Şekli	Tam Boy
▪ Küpeşte	Gold Ayna Paslanmaz



BZM 3004

▪ Cladding	Glass+Stainless
▪ Accesory	Gold Stainless
▪ Ceiling	Lazer
▪ Base	Special PVC
▪ Mirror Type	Full-length
▪ Railing	Gold Stainless Mirror



▪ Kaplama	Gold Paslanmaz
▪ Aksesuar	Altın Ayna Paslanmaz
▪ Tavan	Lazer
▪ Taban	Özel PVC
▪ Ayna Şekli	Tam Boy
▪ Küpeşte	Ayna Paslanmaz



BZM 3005

▪ Cladding	Gold Stainless
▪ Accesory	Gold Stainless Mirror
▪ Ceiling	Laser
▪ Base	Special PVC
▪ Mirror Type	Full-length
▪ Railing	Stainless Mirror





▪ Kaplama	Ayna Paslanmaz
▪ Aksesuar	Ayna Paslanmaz
▪ Tavan	Lazer
▪ Taban	Özel PVC
▪ Ayna Şekli	Tam Boy
▪ Küpeşte	Ayna Paslanmaz



BZM 3006

▪ Cladding	Stainless Mirror
▪ Accesory	Stainless Mirror
▪ Ceiling	Lazer
▪ Base	Special PVC
▪ Mirror Type	Full-length
▪ Railing	Stainless Mirror



KABİN SEÇENEKLERİ / CABIN OPTIONS

▪ Kaplama	Paslanmaz
▪ Aksesuar	Ayna Paslanmaz
▪ Tavan	Lazer
▪ Taban	Özel PVC
▪ Ayna Şekli	Tam Boy
▪ Küpeşte	Ayna Paslanmaz



BZM 3007

▪ Cladding	Stainless
▪ Accesory	Stainless Mirror
▪ Ceiling	Laser
▪ Base	Special PVC
▪ Mirror Type	Full-length
▪ Railing	Stainless Mirror





▪ Kaplama	Paslanmaz
▪ Aksesuar	Gold Paslanmaz
▪ Tavan	Lazer
▪ Taban	Özel PVC
▪ Ayna Şekli	Yarım Boy
▪ Küpeşte	Ayna Paslanmaz



BZM 3008

▪ Cladding	Stainless
▪ Accesory	Gold Stainless
▪ Ceiling	Laser
▪ Base	Special PVC
▪ Mirror Type	Half-length
▪ Railing	Stainless Mirror



▪ Kaplama	Paslanmaz
▪ Aksesuar	Paslanmaz
▪ Tavan	Lazer
▪ Taban	Özel PVC
▪ Ayna Şekli	Tam Boy
▪ Küpeşte	Ayna Paslanmaz



BZM 3009

▪ Cladding	Stainless
▪ Accesory	Stainless
▪ Ceiling	Laser
▪ Base	Special PVC
▪ Mirror Type	Full-length
▪ Railing	Stainless Mirror





▪ Kaplama	Paslanmaz
▪ Aksesuar	Ayna Paslanmaz
▪ Tavan	Lazer
▪ Taban	Özel PVC
▪ Ayna Şekli	Tam Boy
▪ Küpeşte	Ayna Paslanmaz



BZM 3010

▪ Cladding	Stainless
▪ Accesory	Stainless Mirror
▪ Ceiling	Lazer
▪ Base	Special PVC
▪ Mirror Type	Full-length
▪ Railing	Stainless Mirror



▪ Kaplama	Bombeli Lamine Cam
▪ Aksesuar	Ayna Paslanmaz
▪ Tavan	Lazer
▪ Taban	Granit
▪ Ayna Şekli	
▪ Küpeşte	Tek / Tek Boru



BZM 4001

▪ Cladding	Curved Laminated Glass
▪ Accesory	Stainless Mirror
▪ Ceiling	Lazer
▪ Base	Granit
▪ Mirror Type	
▪ Railing	Single / Single Pipe



▪ Kaplama	Lamine Cam
▪ Aksesuar	Ayna Paslanmaz
▪ Tavan	Lazer
▪ Taban	Granit
▪ Ayna Şekli	
▪ Küpeşte	Çift / Tek Boru



BZM 4002

▪ Cladding	Laminated Glass
▪ Accesory	Stainless Mirror
▪ Ceiling	Laser
▪ Base	Granite
▪ Mirror Type	
▪ Railing	Double / Single Pipe

▪ Kaplama	Satin Paslanmaz
▪ Aksesuar	
▪ Tavan	Lazer
▪ Taban	Özel PVC
▪ Ayna Şekli	Tam Boy
▪ Küpeşte	Paslanmaz Boru



BZM 5001

▪ Cladding	Satin Stainless
▪ Accesory	
▪ Ceiling	Lazer
▪ Base	Special PVC
▪ Mirror Type	Full-length
▪ Railing	Stainless Pipe





▪ Kaplama	ESB Boyalı
▪ Aksesuar	
▪ Tavan	Spot
▪ Taban	Saç
▪ Ayna Şekli	
▪ Küpeşte	Koruma Bandı



BZM 5002

▪ Cladding	ESB Painted
▪ Accesory	
▪ Ceiling	Spot
▪ Base	Sheet Steel
▪ Mirror Type	
▪ Railing	Protective Band



CAM KABINLER / GLASS CABINS



AE113

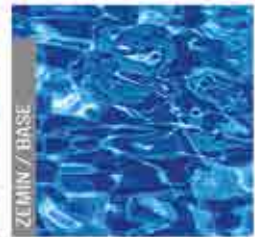
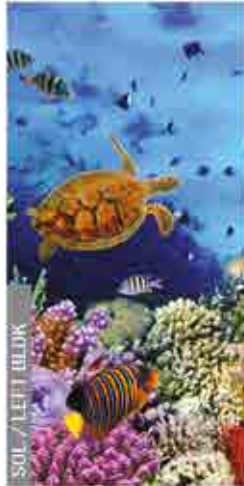

AE183



AE232



KAPI / DOOR



SOL / LEFT BLOK

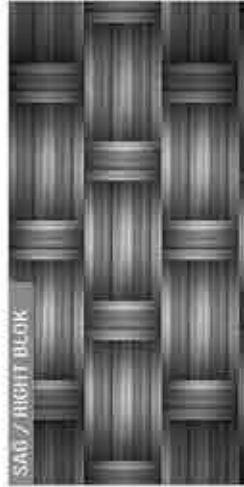

SAG / RIGHT BLOK



TAVAN / CEILING



ZEMIN / BASE

AE235



KAPI / DOOR



SOL / LEFT BLOK



SAG / RIGHT BLOK



TAVAN / CEILING

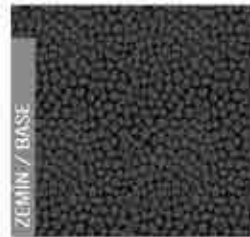

ZEMIN / BASE

AE406



KAPI / DOOR



SOL / LEFT BLOK



SAG / RIGHT BLOK



TAVAN / CEILING



ZEMIN / BASE

AE292

TAVAN ÇEŞİTLERİ / CEILING OPTIONS

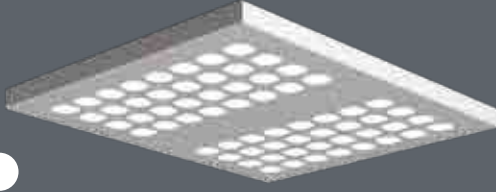

▶ ▶ ▶ BZM-TAV-1010

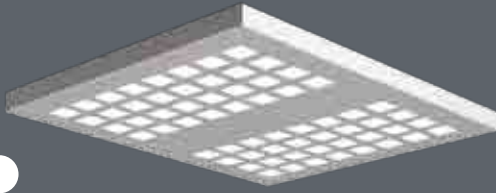

▶ ▶ ▶ BZM-TAV-1011

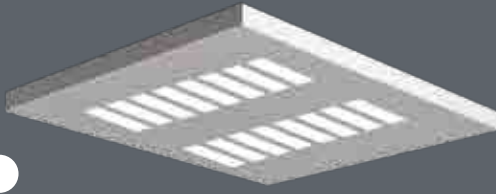

▶ ▶ ▶ BZM-TAV-1012

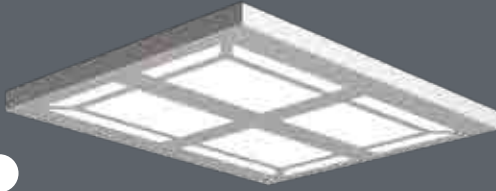

▶ ▶ ▶ BZM-TAV-1013

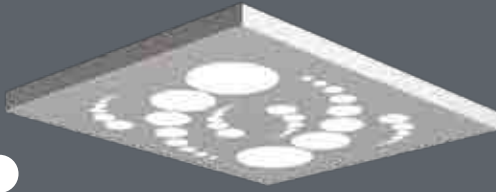

▶ ▶ ▶ BZM-TAV-1014

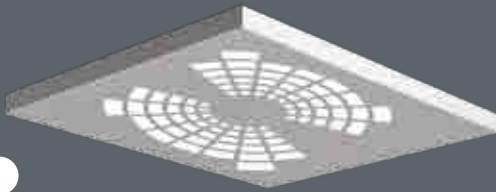

▶ ▶ ▶ BZM-TAV-1015

▶ ▶ ▶ BZM-TAV-1016

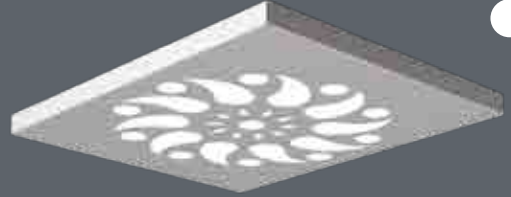

▶ ▶ ▶ BZM-TAV-1017

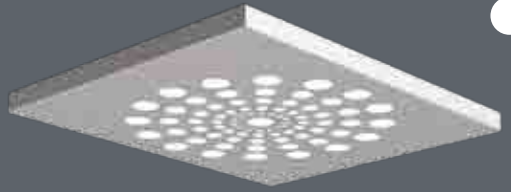

▶ ▶ ▶ BZM-TAV-1018

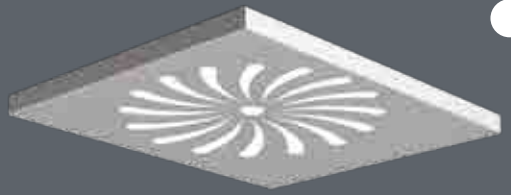

▶ ▶ ▶ BZM-TAV-1019



▶ ▶ ▶ BZM-TAV-1020



▶ ▶ ▶ BZM-TAV-1021

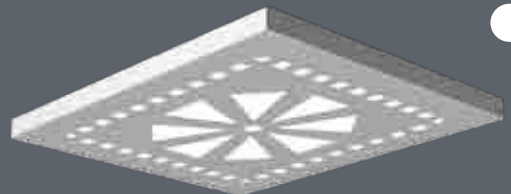

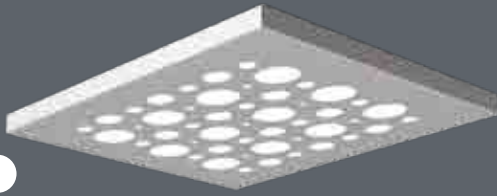

▶ ▶ ▶ BZM-TAV-1022



▶ ▶ ▶ BZM-TAV-1023



▶ ▶ ▶ BZM-TAV-1024

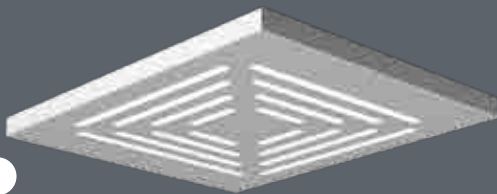

▶ ▶ ▶ BZM-TAV-1025

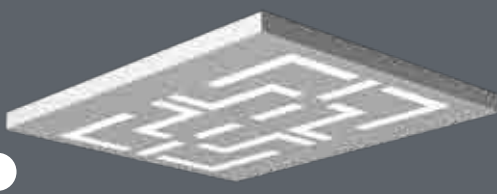

▶ ▶ ▶ BZM-TAV-1026

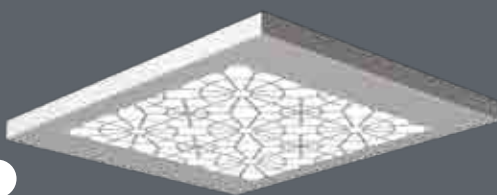

▶ ▶ ▶ BZM-TAV-1027

▶ ▶ ▶ BZM-TAV-1028

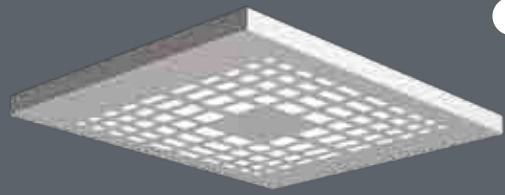

▶ ▶ ▶ BZM-TAV-1029

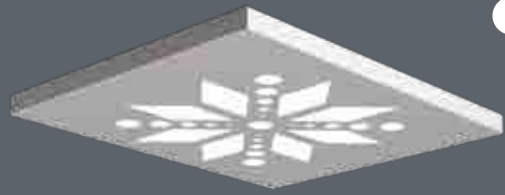

▶ ▶ ▶ BZM-TAV-1030

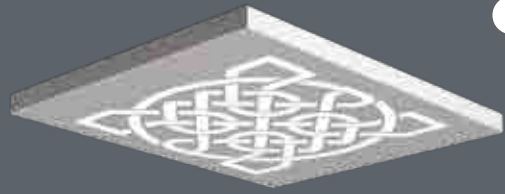

▶ ▶ ▶ BZM-TAV-1031

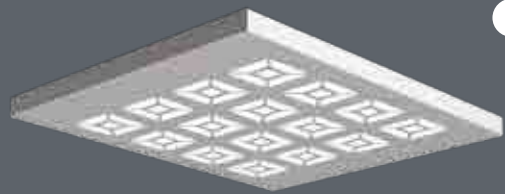

▶ ▶ ▶ BZM-TAV-1032

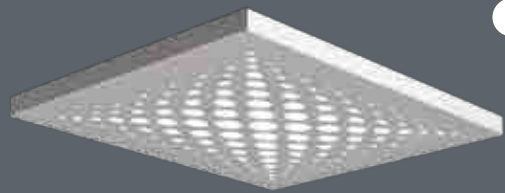

▶ ▶ ▶ BZM-TAV-1033

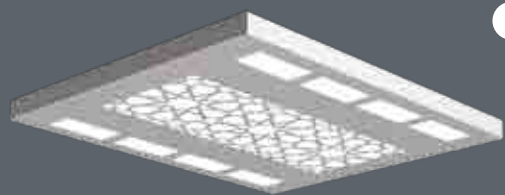

PASLANMAZLAR / STAINLESS OPTIONS



DB-01



DBT



DC-01



DG-01



DG-02



DG-05



DG-06



DG-10



DG-11



DG-MZK



DG-MZK



DG03



DGT



DM-01



DM-02



DM-04



DM-05



DM-07



DM-08



DM-09



DM-010



DM-011



DM-013



DM-015



DM-017



DRT



DR-01



DM03

LAMİNAT SEÇENEKLERİ / LAMINATE OPTIONS



Abanoz
Ebony

Abant Cevizi
Abant Walnut

Açık Meşe
Light Oak

Açık Zebrano
Light Zebrano

AK Meşe
White Oak

Akçaağaç
Maple

Atlantis
Atlantis



Avanos Cevizi
Avanos Walnut

Baltimore Cevizi
Baltimore Walnut

Bambu
Bamboo

Black Veneer
Black Veneer

Ceviz
Walnut

Chuy
Chuy

Çiçekli Beyaz
Floral White



Diamond Beyaz
Diamond White

Gold Somoeset
Gold Somoeset

Ilgaz Meşe
Ilgaz Oak

İlayda
İlayda

Kahve Koton
Coffee Cotton

Katmandu
Kathmandu

Koton Gri
Cotton Grey



Koyu Meşe
Dark Oak

Koyu Zebrano
Dark Zebrano

Madera
Madera

Metropolis
Metropolis

Napolyon Kiraz
Napoleon Cherry

Ozigo
Ozigo

Par. Açık Emperador
Bright Light Emperador



Parlak Aytozu Beyaz
Bright Moond White

Parlak Aytozu Siyah
Bright Moondus Black

Parlak Beyaz Yaprak
Bright White Leaf

Par. Koyu Emperador
Bright Dark Emperador

Parlak rainbow Siyah
Bright Rainbow Black

Parlak Siyah Yaprak
Bright Black Leaf

Rain Black
Rain Black

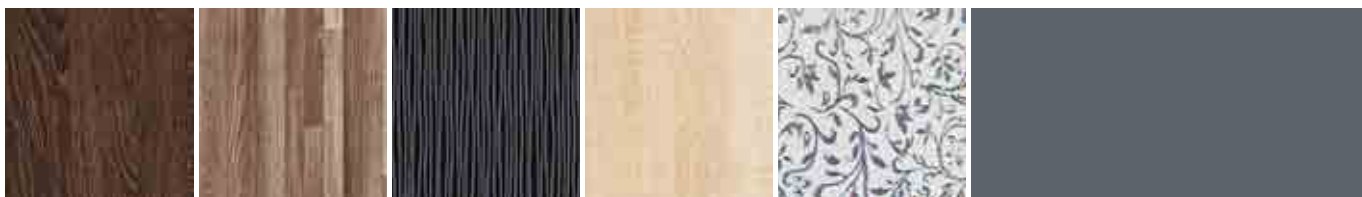

Rio Meşe
Rio Oak

Silver Somersset
Silver Somersset

Siyah İnci
Black Pearl

Tuana
Tuana

Yıldızlı Beyaz Nergiz
Starry White Narcissus



BZM-KP-010



BZM-KP-011



BZM-KP-012



BZM-KP-013



BZM-KP-014



BZM-KP-015



AYT-KP-016

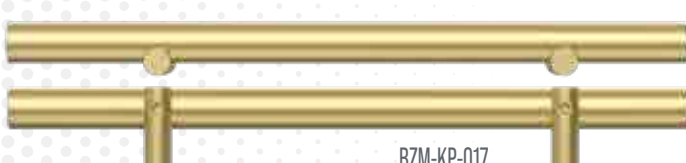

BZM-KP-017



BZM-KP-018

Farkli Renklerle
**KOMBİNE
SEÇENEĞİ**





AEZ148



AEZ149



AEZ150



AEZ151



AEZ152



AEZ153



AEZ156



AEZ157



AEZ158

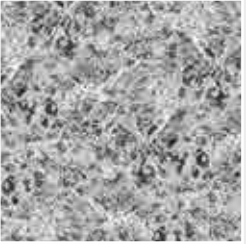

AEZ209

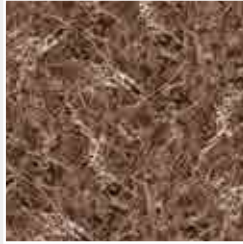

AEZ210

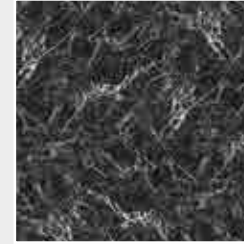

AEZ211



AEZ3000



AEZ4100



AEZ019



AEZ020



AEZ021



AEZ022



AEZ023

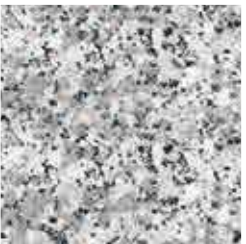

AEZ024



AEZ025



AEZ026

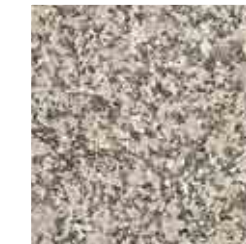

AEZ027



AEZ028

70X90 RAY KONSOLLARI / 70X90 RAIL GUIDES

- Yüksek mukavemet
- Her model ray tırnağına uygundur.
- *High durability*
- *Suitable for all rail nail models.*



60X80 RAY KONSOLLARI / 60X80 RAIL GUIDES

- 80-110 mm hareket payı
- Her model ray tırnağına uygundur.
- *80-110 mm clearance*
- *Suitable for all rail nail models.*



60x100 RAY KONSOLLARI / 60x100 RAIL GUIDES

- 100-160 mm hareket payı
- Her model ray tırnağına uygundur.
- *100-160 mm clearance*
- *Suitable for all rail nail models.*





60X120 RAY KONSOLLARI / 60X120 RAIL GUIDES

- 120-200 mm hareket payı
- Yeni yönetmeliğe uygun civatalı sistem
- Her model ray tırnağına uygundur.
- *120-200 mm clearance*
- *Bolted system conforms new regulation*
- *Suitable for all rail nail models.*



60X150 RAY KONSOLLARI / 60X150 RAIL GUIDES

- 150-250 mm hareket payı
- Yeni yönetmeliğe uygun civatalı sistem
- Her model ray tırnağına uygundur.
- İstenilen kalınlık ve ölçülerde üretim yapılabilir.
- *150-250 mm clearance*
- *Bolted system conforms new regulation*
- *Suitable for all rail nail models.*
- *Can be produced with demanded thickness and dimensions.*



50X180 HAREKETLİ RAY KONSOLLARI / 50X180 MOVABLE RAIL GUIDES

- 50-180 mm hareket payı
- Her model ray tırnağına uygundur.
- *50-180 mm clearance*
- *Suitable for all rail nail models.*

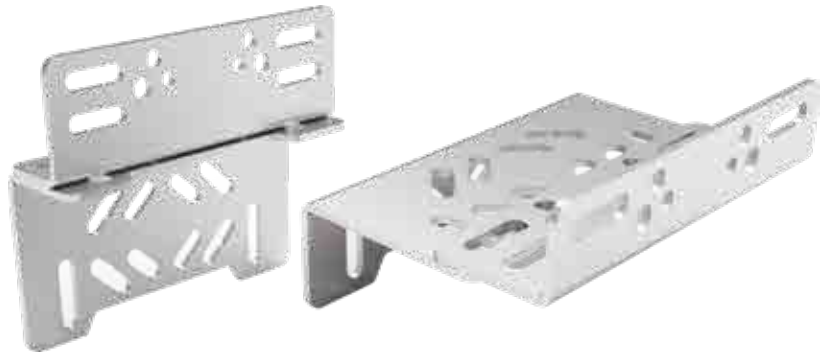

50X70 RAY KONSOLLARI / 50X70 RAIL GUIDES



- 70-100 mm hareket payı
- Yeni yönetmeliğe uygun civatalı sistem
- Her model ray tırnağına uygundur.
- İstenilen kalınlık ve ölçülerde üretim yapılabilir.

- 70-100 mm clearance
- Bolted system conforms new regulation
- Suitable for all rail nail models.
- Can be produced with demanded thickness and dimensions.

50X70 RAY KONSOLLARI / 50X70 RAIL GUIDES

- 100-150 mm hareket payı
- Yeni yönetmeliğe uygun civatalı sistem
- Her model ray tırnağına uygundur.
- İstenilen kalınlık ve ölçülerde üretim yapılabilir.

- 100-150 mm clearance
- Bolted system conforms new regulation
- Suitable for all rail nail models.
- Can be produced with demanded thickness and dimensions.



50X100 RAY KONSOLLARI / 50X100 RAIL GUIDES

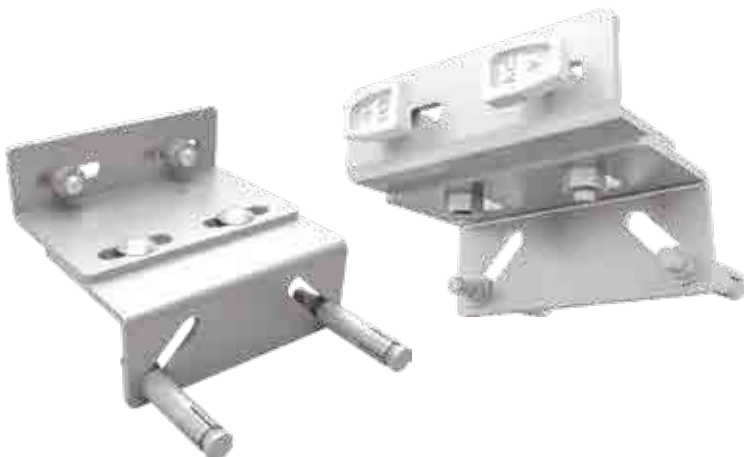

- 120-180 mm hareket payı
- Yeni yönetmeliğe uygun civatalı sistem
- Her model ray tırnağına uygundur.
- İstenilen kalınlık ve ölçülerde üretim yapılabilir.

- 120-180 mm clearance
- Bolted system conforms new regulation
- Suitable for all rail nail models.
- Can be produced with demanded thickness and dimensions.



50X120 RAY KONSOLLARI / 50X120 RAIL GUIDES



- 120-200 mm hareket payı
 - Yeni yönetmeliğe uygun civatalı sistem
 - Her model ray tırnağına uygundur.
 - İstenilen kalınlık ve ölçülerde üretim yapılabilir.
-
- 120-200 mm clearance
 - Bolted system conforms new regulation
 - Suitable for all rail nail models.
 - Can be produced with demanded thickness and dimensions.

HİDROLİK KONSOL

- Yeni yönetmeliğe uygun civatalı sistem
- Her model ray tırnağına uygundur.
- İstenilen kalınlık ve ölçülerde üretim yapılabilir.

- Bolted system conforms new regulation
- Suitable for all rail nail models.
- Can be produced with demanded thickness and dimensions.



AĞIRLIK RAY KONSOLU / HYDRAULIC RAIL GUIDE



- Yeni yönetmeliğe uygun civatalı sistem
- Her model ray tırnağına uygundur.
- İstenilen kalınlık ve ölçülerde üretim yapılabilir.

- Bolted system conforms new regulation.
- Suitable for all rail nail models.
- Can be produced with demanded thickness and dimensions.



AYARLI KUYU BÖLMESİ / ADJUSTABLE WELL COMPARTMENT

- Yüksek mukavemet
- İstenilen kalınlık ve ölçülerde üretim yapılabilir.
- Civatalı ayarlanabilir sistem
- Montaj kolaylığı
- *High durability*
- *Can be produced with demanded thickness and dimensions.*
- *Adjustable bolted system*
- *Easy mounting*
- 2 adet 50x70 duvar koAnsolu (5 mm)
- 2 adet 50x70 ağırlık raş konsolu
- 2 adet 60x80 ana ray konsolu
- 1 adet 60x80 ana ray duvar konsolu
- 2 x 50x70 wall guide (5 mm)
- 2 x 50x70 rack guide
- 2 x 60x80 main rail guide
- 1 x 60x80 main rail wall guide

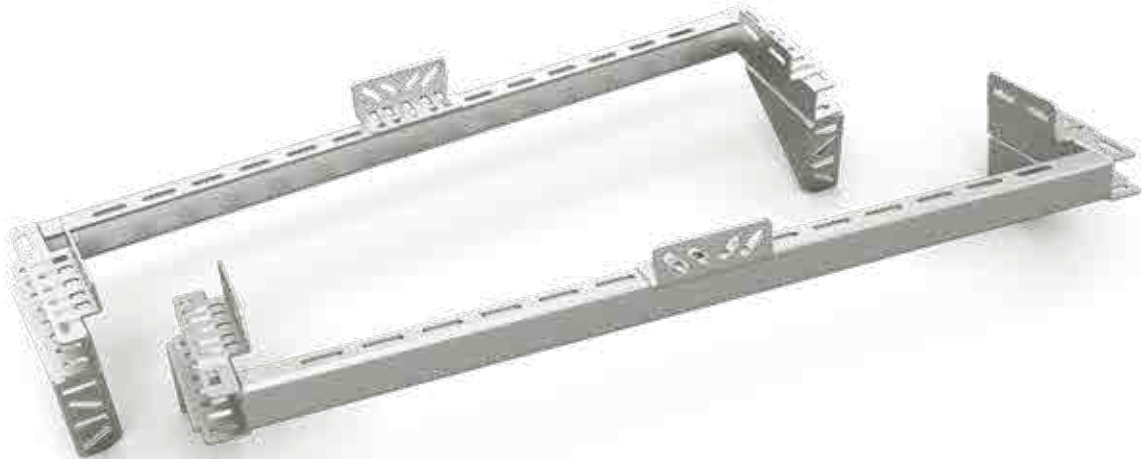





MAKİNE ŞASESİ / MACHINE CHASSIS

▪ NPU üretim

- İstenilen kalınlık ve ölçülerde üretim yapılabilir.
- Yüksek mukavemet
- Civatalı ayarlanabilir sistem
- Montaj kolaylığı

▪ NPU production

- Can be produced with demanded thickness and dimensions.
- High durability
- Adjustable bolted system
- Easy installation





500 KG KADAR / UP TO 500 KG

▪ NPU üretim

- İstenilen kalınlık ve ölçülerde üretim yapılabilir.
- Yüksek mukavemet
- Civatalı ayarlanabilir sistem
- Montaj kolaylığı

Dikmeler 80'lik NPU
Şase üst 100'lük NPU
4 adet makine lastiği
Uzunluk 1300 mm x Yükseklik 900 mm

▪ NPU production

- Can be produced with demanded thickness and dimensions.
- High durability
- Adjustable bolted system
- Easy installation

Perpendiculars 80 mm NPU, hasis top 100 mm NPU, 4 x machine tires
Lenght 1300 mm x Height 900 mm



1000 KG KADAR / UP TO 1000 KG



▪ NPU üretim

- İstenilen kalınlık ve ölçülerde üretim yapılabilir.
- Yüksek mukavemet
- Civatalı ayarlanabilir sistem
- Montaj kolaylığı

Dikmeler 100'lük NPU
Şase üst 120'lik NPU
8 adet makine lastiği
Uzunluk 1450 mm x Yükseklik 1000 mm

▪ NPU production

- Can be produced with demanded thickness and dimensions.
- High durability
- Adjustable bolted system
- Easy installation

Perpendiculars 100 mm NPU
Chassis top 120 mm NPU
8 x machine tire
Lenght 1450 mm x Height 1000 mm

FLANŞ KONSOL / FLANGE GUIDE

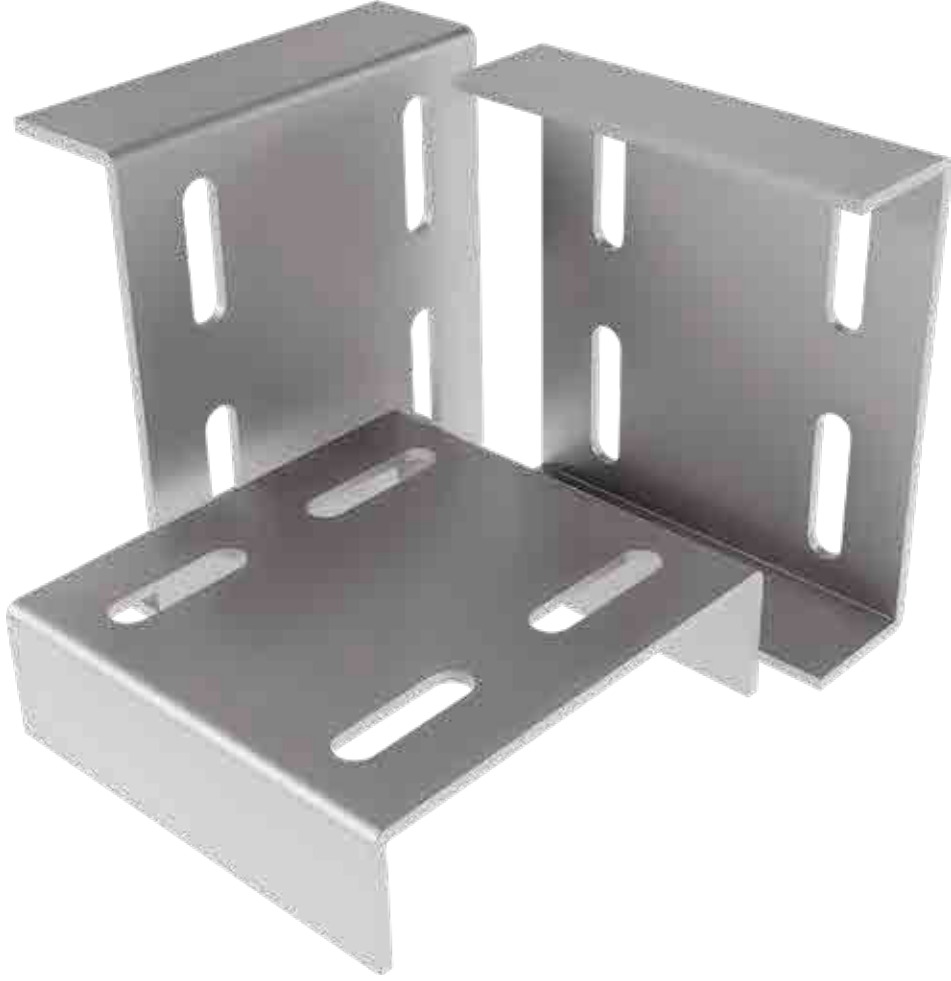

KUYU DİBİ MERDİVEN / WELL BOTTOM LADDER





MAKİNE TAKOZU / *MACHINE WEDGE*



SWİCH KESİCİ LAMA / *SWİCH CUTTER PLATE*

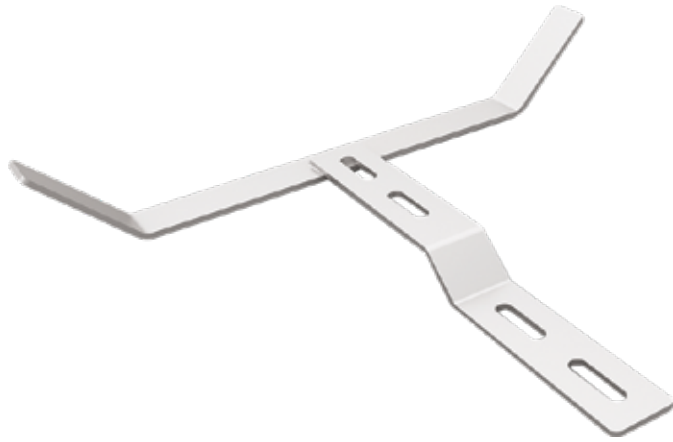

KASNAK KORUMA / *PULLEY PROTECTION*



KALDIRMA KANCASI / LIFTING HOOK



- Kolay montaj
- İstenilen kalınlık ve ölçülerde üretim yapılabilir.
- *Easy assembly*
- *Can be produced with demanded thickness and dimensions.*

OTOMATİK KAPI KONSOLU / AUTOMATIC DOOR GUIDE

- Civatalı sistem
- Her model kapıya uygundur.
- İstenilen kalınlık ve ölçülerde üretim yapılabilir.
- *Bolted system*
- *Suitable for all door models*
- *Can be produced with demanded thickness and dimensions*



OTOMATİK KAPI KONSOLU / AUTOMATIC DOOR GUIDE



- Civatalı sistem
- Her model kapıya uygundur.
- İstenilen kalınlık ve ölçülerde üretim yapılabilir.
- *Bolted system*
- *Suitable for all door models*
- *Can be produced with demanded thickness and dimensions.*



LAMA / FISH PLATE

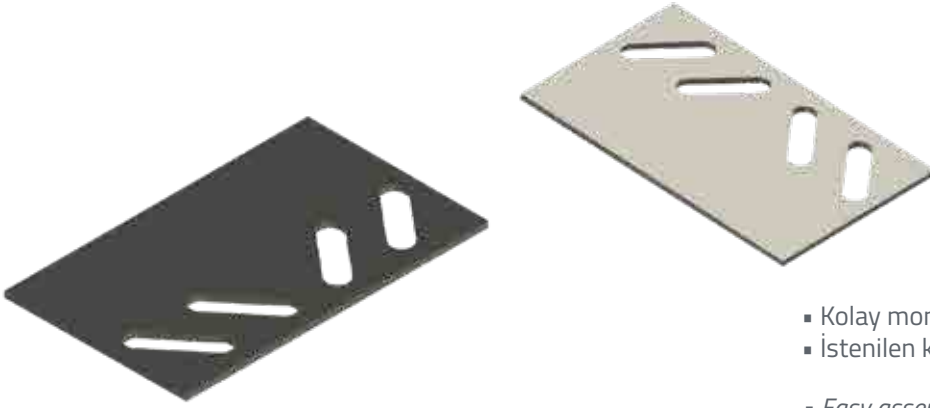

- Kolay montaj
- İstenilen kalınlık ve ölçülerde üretim yapılabilir.
- *Easy assembly*
- *Can be produced with demanded thickness and dimensions.*

ÇİFT TARAFLI LAMA / DOUBLE SIDED PLATE

- Kolay montaj
- İstenilen kalınlık ve ölçülerde üretim yapılabilir.
- *Easy assembly*
- *Can be produced with demanded thickness and dimensions.*

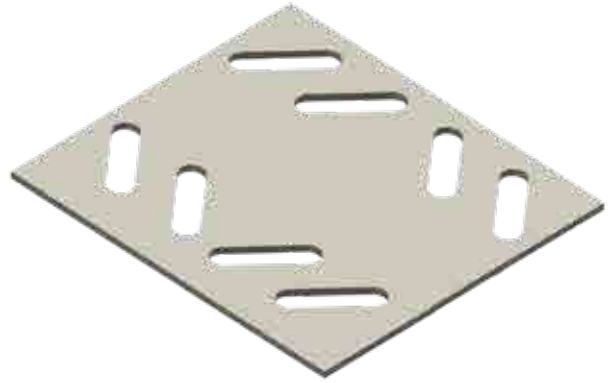

KÖR KASA / SUBFRAME



- İstenilen kalınlık ve ölçülerde üretim yapılabilir.
- *Can be produced with demanded thickness and dimensions.*

ASANSÖR EKİPMANLARI / ELEVATOR EQUIPMENT



Halat / Rope



Kuyu Dibi Tampon / Well Bottom Buffer



Hidrolik Tampon / Hydraulic Buffer



Halat Şapkası / Rope Cap



Klemens / Claps



Halat Şişesi / Rope Attachment



Yağdanlık / Lubricator



Yağ Toplama Kabı / Oil Collection Container



Fleksible Takozu / Flexible Wedge



Çelik Dübel / Steel Dowel



Tırnak / Nail



● Tırnak / Nail



Kilit / Lock



Diktatör / Shock Absorber



Pompa / Pump



Elektrik Panosu / *Electricity Panel*



Kablo Kanalı / *Cable Duct*



Siprial Boru / *Spiral Pipe*



Mantar Stop / *Mushroom Stop*



Elektrot / *Electrode*



Makaralı Swich / *Roller Switch*



Kasnak / *Pulley*



Regülatör / *Regulator*



Paten / *Skate*



Vida - Somun / *Screw - Nut*



Halat Tutucu / *Rope Holder*



Misina / *Nylon Thread*



Etek Sacı / *Skirt Sheet*



Korkuluk / *Handrails*



Barit Ağırlık / *Counterweight*



Pilli Alarm Butonu
Battery Powered Alarm Button



Kuyu Dibi İkaz Paneli
Pit Bottom Panel



Elektrik Dağıtım Panosu
Electricity Switchboard



Kutulu Start Butonu
Boxed Start Button



Start/Stop Butonu / Start / Stop Button



Fan / Fan



Çeşitler / Varieties
6,5 - 8 - 10 - 10mm
Halat Şişesi / Rope Attachment



Çelik Dübel 12x90 / Steel Dowel 12x90



Yağdanlık / Lubricator



İzole Bant / Isolating Tape

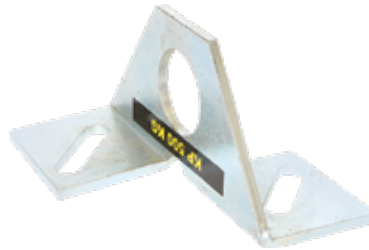

Askı Kancası / Suspension Hook



Radansa / Radansa



Makine Şasesi / Machine Chassis



Çeşitler/ Varieties
T1 - T2- T3 - T4

Döküm Tırnak / Cast Nail



Çeşitler / Varieties
250 - 370mm

Kablo Bağı / Cable Tie



Konsol / Console



Çeşitler / Varieties
6 - 6,5 - 8 - 10 - 12 mm
Halat Klemens / Cable Clamps



Kuyu Dibi Merdiven
Well Bottom Ladder



90'lık Paten Bloğu / Skating Block 90 mm



50'lik Paten Bloğu / Skating Block 50 mm



70'lik Döküm Paten Bloğu
Skating Block 70 mm



Saplamalı Makine Takoğu
Machine Wedge with Studs



Switch Resetli / Switch with Rset



Makaralı Switch Resetli
Roller Switch with Reset



Halat Atma Pimi / Rope Throwing Pin



T Lama / Fish Plate



Kuyu Dibi Tampon Takımı
Well Bottom Buffer Set



Kasnak Koruma Takım
Pulley Protection Kit



Yardımcı Kontakt Bloğu
Auxiliary Contact Block



Tüp Manyetik / *Magnetic Tube*



Pako Şalter / *Pako Switch*



Otomatik Sigorta
Automatic Switch



Otomatik Sigorta
Automatic Switch



Mono stabil Manyetik
Mono stable Magnetic



Mini Kontaktör
Mini Contactor



Mekanik Termik
Thermal Relay



Kuyu Dibi Revizyon Seti
Pit Revision Kit



Kontaktör
Contactor



Kontaktör
Contactor



Kare Diyot
Square Diode



Kaçak Akım Koruma Rölesi
Residual Current Protection Relay



Eİ Terminali
Manual Terminal



Darbe Akım Şalteri
Pulse Current Switch



Baypass Seli İkaz
Flood Warning Button



Buzzer / Buzzer



Boş Buton / Empty Button Box



Akü / Battery



Alarm Butonu / Alarm Button



Bara / Busbar



Deprem Yangın Sensörü
Earthquake Fire Detector



Kaydırmaz Band / Anti-Slip Band



Kesme Taşı / Cutting Stone



Yeşil Kontak / Green Contact



Makina Takozu / Machine Wedge



Role / Relay



Vavien Anahtarı / Vavien Key



Vavien Priz / Vavien Socket



Yüksek Papuç / Cable Lug

DİŞLİLİ MAKİNE / GEARED MACHINE



AKIŞ



MONTARI



ALBERTO SASSI



AKAR



GEM



NAGEL



KLEEMANN



SICOR



DIŞLİSİZ MAKİNE / GEARLESS MACHINE



AKIŞ



ALBERTO SASSI



KLEEMANN



AKAR



LAFERT



WITTUR



GEM



HEPU



KABLO DURUMU / CABLE STOCKS

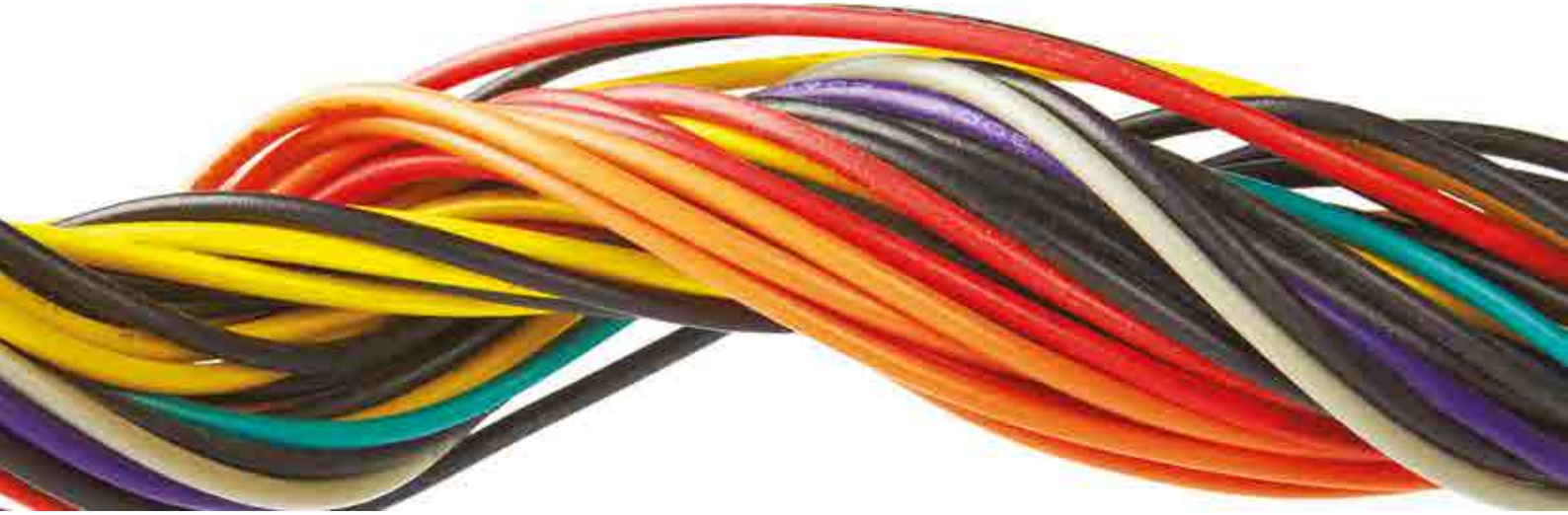

Asansör kullanılan bütün kablo grubu stoklarımızda mevcuttur.
We have every cable type used in elevators in our stocks.



● Antigran Kablo / *Antigran Cable*



● Antigran Kablo / *Antigran Cable*



● 1'lik Kablo / *Single Cable*



● 13'lü Digital Kablo
13 Core Digital Cable



● 4'lük Kablo / *4 Core Cable*



● 0,75'lik Kablo / *0,75 Core Cable*



● Fleksible Kablo / *Fleksible Kablo*



● 0,75'lik Kablo / *0,75 Core Cable*



● 0,75'lik Kablo / *0,75 Core Cable*

HİDROLİK YÜK TAŞIMA SİSTEMİ / HYDRAULIC LOAD CARRYING SYSTEM



Kompakt yük taşıma sistemi, depo ve fabrikalardaki kısa mesafeli yükseklikler için ideal bir çözümdür. 1.500 kg'na kadar olan yükler için komple ve ekonomik çözüm sağlar.

Komple sistem olarak verilir. Makine dairesine ihtiyaç duymaz ve 98/37/AT Makine direktifine uygun ürün tip belgesine sahiptir.

The compact load handling system is an ideal solution for short heights in warehouses and factories. It provides a complete and economical solution for loads up to 1.500 kg.

It is provided as a complete system and does not need a machine room and has a product type certificate which conforms the 98/37/AT Machinery directive.

Types

Troller

- C450N
- C650N
- C1000N

Car Sling

- CSG200N
- CSG450N
- CSG650N
- CSG1000N
- CSG1200N
- CSG1500N



- Maksimum seyir mesafesi 11,5 metre, Durak sayısı 3.
- Maksimum platform ölçüleri 2.000 mm x 1.600 mm
- Maksimum kapasite 1.500 kg
- *Maximum cruising distance 11,5 metre, Number of stops 3.*
- *Maximum platform dimensions 2.000 mm x 1.600 mm*
- *Max capacity 1.500 kg*

MODEL	C450	C650	C1000	CSG200	CSG450	CSG650	CSG1000	CSG1250N	CSG1500N
KARKAS / CARCASS	N KARKAS			L KARKAS					
MAKS. KAPASİTE (kg) / MAX. CAPACITY (kg)	350/450	650	1000	300	350/450	650	1.000	1.250	1.500
MİN. KUYU DİBİ (mm) / MIN. WELL BOTTOM (mm)	220			430	450	450	460	380	380
MİN. SON KAT (mm) / MIN. HEADROOM (mm)	2.200								
PLATFORM GENİŞLİĞİ (mm) / PLATFORM WIDTH (mm)	1.250	1.250	1.400	1.000	2.200	1.250	1.250	1.800	2.000
PLATFORM DERİNLİĞİ (mm) / PLATFORM DEPTH (mm)	1.100	1.100	1.300	1.000	1.100	1.100	1.300	1.500	1.600
KUYU GENİŞLİĞİ (mm) / WELL WIDTH (mm)	1.300	1.300	1.450	1.050	1.300	1.300	1.450	1.850	2.050
KUYU DERİNLİĞİ / WELL DEPTH	1.445	1.445	1.655	1.325	1.445	1.445	1.675	1.900	2.000

OTOMATİK / MANUEL KAPI / AUTOMATIC/MANUAL DOOR



Fermator

ida

lift
asansör

FLUENT

KLEFER
Automatic Lift Doors

PROLIFT
Automatic Doors For Lifts

HAS
ELEVATOR

emay
Automatic Doors for Lifts



Güçlendirilmiş 6 panel otomatik kapı
Reinforced 6 panel automatic door



Satine Paslanmaz
Satine Stainless



Esv Çerçeve Cam Kapı
Esv Frame Glass Door



OTOMATİK KAPI / *AUTOMATIC DOOR*



"4 Katlanır Pane
4 Folding Panels



3 Katlanır Panel
3 Folding Panels



2 Katlanır Panel
2 Folding Panels

MANUEL KAPI / *MANUAL DOOR*



RAL 7032
İstenilen RAL Kodu Uygulanır
Desired RAL code can be applied



Satine Paslanmaz
Satine Stainless

OTOMATİK / MANUEL KAPI

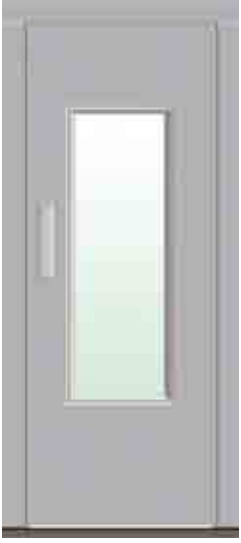

● Kapı 1 / Door 1



● Kapı 2 / Door 2



● Kapı 3 / Door 3



● Kapı 4 / Door 4



● Kapı 5 / Door 5



● Kapı 6 / Door 6



● Kapı 7 / Door 7



● Kapı 8 / Door 8



● Kapı 9 / Door 9



● Kapı 10 / Door 10



● Kapı 11 / Door 11



● Kapı 12 / Door 12



● Kapı 13 / Door 13



● Kapı 14 / Door 14



● Kapı 15 / Door 15



● Kapı 16 / Door 16



● Kapı 17 / Door 17



● Kapı 18 / Door 18



● Kapı 19 / Door 19



- Manuel asansörlerde güvenlik kapısı (kabin kapısı)
- W tipi katlanır kapı
- Safety door (cabin door) in manual elevator
- W type folding door



● *Giyotin Kapı* / Guillotine Door

RAY ve RAY KOMPONENTLERİ
RAIL and RAIL COMPONENTS

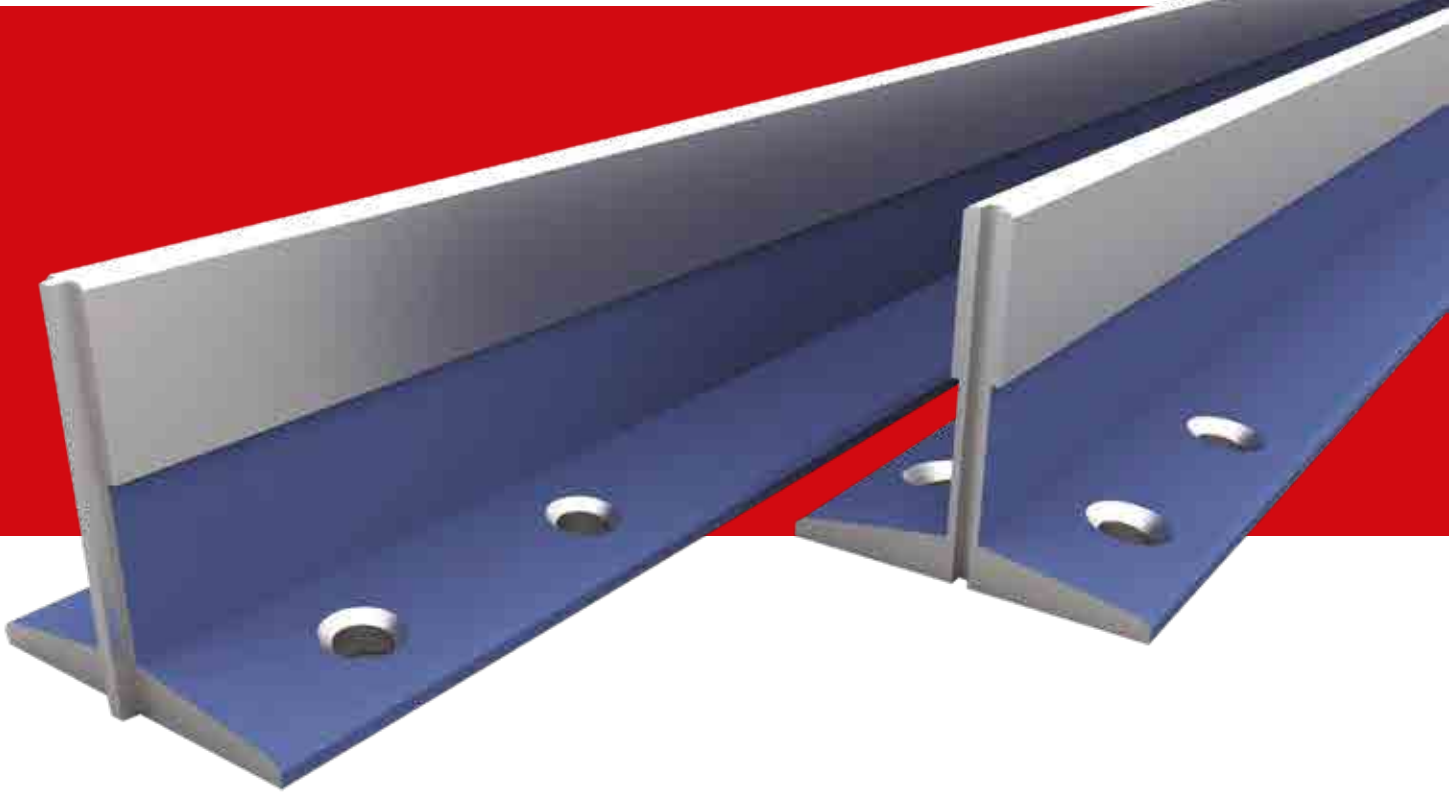

CELIKRAY
ASANSÖR KILAVUZ RAYLARI

ÖZRAY
Asansör Ray Sistemleri
Elevator Rail Systems

TÜRKELİ RAY®

Türkray



TEKNİK ÖZELLİKLER / TECHNICAL CHARACTERISTICS

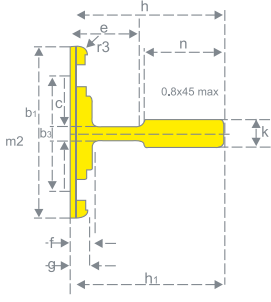

KOD / NO	EBAT / SIZE	s	q	e	Ixx	Wxx	Iyy	Wyy	Iyy	
		cm ²	Kg/m	cm	cm ⁴	cm ³	cm ⁴	cm ³	cm ⁴	
TOLERANSLA R - TOLERANCES										
T50/A	50 X 50 X 5 mm	4.75	3.73	1.43	11.24	3.15	1.54	5.25	2.1	1.05
T70/A	70 x 65 x 9 mm	9.40	7.37	2.03	40.95	9.16	2.08	18.86	5.38	1.41
T89/A	89 x 62 x 16 mm	15.77	12.38	2.03	59.83	14.35	1.94	52.41	11.78	1.82
T90/A	90 x 75 x 16 mm	17.25	13.54	2.61	102.0	20.86	2.43	52.48	11.66	1.74
T125/B	125 x 82 x 16 mm	22.82	17.91	2.43	151	26.16	2.572	159.1	25.46	2.641

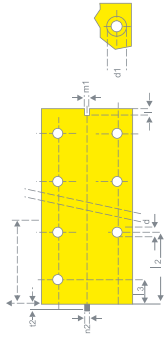

BOYUTLAR / DIMENSIONS

KOD / NO	EBAT / SIZE	b1	h1	h	k	n	c	g	f	rs	m1	m2	t1	t2	
		TOLERANSLA R - TOLERANCES													
		±0.50	±0.10		±0.10	+3			±0.75		±0.60	±.60	±0.10	±0.10	
T50/A	50 X 50 X 5 mm	50	50	49	5.0	27	4.25	-	7.3	1.0	2.60	2.55	3.50	3	
T70/A	70 x 65 x 9 mm	70	65	64	9.0	34	6.0	6.0	8.0	1.5	3.0	2.97	3.50	3	
T89/A	89 x 62 x 16 mm	89	62	61	16.0	34	10.0	7.9	11.1	3.0	6.4	6.37	4.50	4	
T90/A	90 x 75 x 16 mm	90	75	74	16.0	42	10.0	8	10	4.0	6.4	6.37	4.50	4	
T125/B	125 x 82 x 16 mm	125	82	81	16	42	10	8	12	4.0	6.4	6.37	-	-	

DELİK VE BAĞLANTI PARÇALARI / HOLES & FISHPLATES

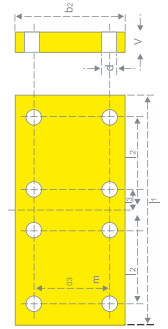

KOD / NO	EBAT / SIZE	d	d	l	b2	b3	l1	l2	l3	v	CİVATA	
		TOLERANSLA R - TOLERANCES										
						±0.2	±1.5	±0.2	±0.2	±2	UNI5727 DIN601	
T50/A	50 X 50 X 5 mm	9			50	30	200	75	25	8	M8X25	
T70/A	70 x 65 x 9 mm	13			70	42	190	105	25	8.5/10	M12X35	
T89/A	89 x 62 x 16 mm	13			89	57.2		114.3	38.1		M12X35	
T90/A	90 x 75 x 16 mm	13			90	57.2		114.3	38.1		M12X35	
T125/B	125 x 82 x 16 mm	17			130	79.4	305	114.3	38.1	17	M16X50	



● Delikli Ray Laması / Perforated Rail Fish Plate



● Ray ebat çeşitleri
Rail size options

ASANSÖR PANO / ELEVATOR PANEL



* Tümüleşik asansör kumanda kartı ve inverter * EN81-1 + A3 standartlarına uygun * Senkron ve asenkron motorlar ile uyumlu * Incremental encoder (5v Ttl & 10-30v Htl) veya Absolute Encoder (Endat & Ssi & Sincos & Biss) ile uyumlu * 4 m/sn hıza ve 64 durağa kadar çalışabilme * 8 asansöre kadar grup kumanda * Erken kapı açma ve seviyeleme * Hızlı kalkış ve direkt duruş * Ups ile kurtarma (Kolay Yöne) * Çift girişli asansörlerde 2 kapıyı duraklara göre bağımsız kontrol etme özelliği * Arem el terminali ile can bus üzerinden herhangi bir noktadan kontrol * Dijital kuyu öğrenme

**Integrated elevator control card and inverter *Complies EN81-1 + A3 standards *Compatible with synchronous and asynchronous motors *Competible with Incremental encoder (5v Ttl & 10-30v Htl) or Absolute Encoder (Endat & Ssi & Sincos & Biss) *May work up to 4 m/s speed and 64 stops *Group control up to 8 elevators *Early door opening and leveling *Quick start and direct stop *Recovery with Ups (Easy Direction) *Independent control of 2 doors according to stops in doubleentry elevators *Control from any point via can bus with Arem manual terminal *Digital well learning*

HİDROLİK PANO / HYDRAULIC PANEL

* EN81-1 + A3 standartlarına uygun * Arl 300 kumanda kartlı * Direk & yıldız üçgen & softstart ile yol verme * 1.2 m/sn hıza ve 24 durağa kadar çalışabilme özelliği * 4 asansöre kadar grup çalışabilme * Ups ile kurtarma seçeneği * Erken kapı açma ve seviyeleme * Manuel ve her tip otomatik kapıya uygun * Çift girişli asansörler için çift otomatik kapı kontrolü * 7 Segment & gray kod & binary kod gösterge çıkışları * Pano dolabı aydınlatma ve fan * Seri haberleşme kartı ile kolay montaj

**Complies EN81-1 + A3 standards *With Arl 300 with control card *Direct, delta, soft start starters *May work up to 1.2 m/s speed and 24 stops *Group control up to 4 elevators *Recovery option with ups *Early door opening and leveling *Suitable for all types of automatic doors along with manual doors *Double automatic door control for double entry elevators *7 Segment & gray code & binary code indication outputs *Elevator power cabinet lighting and fan *Easy installation with serial communication card*



MRL PANO / MRL PANEL



- * EN81-1 + A3 standartlarına uygun
- * Senkron ve asenkron motorlar ile uyumlu
- * Arl 300 kumanda kartlı
- * Arkel A-drive & Fuji Frenic-lift & Ziehl-Abegg Zetadyn inverter seçenekleri
- * 1.6 m/sn hız ve 24 durağa kadar çalışabilme özelliği
- * 4 asansöre kadar grup çalışabilme
- * Ups ile kurtarma seçeneği (Kolay yöne)
- * Erken kapı açma ve seviyeleme
- * Manuel ve her tip otomatik kapiya uygun
- * Çift girişli asansörler için çift otomatik kapı kontrolü
- * 7 Segment & Gray Kod & Binary kod göstere çıkışları
- * Pano dolabı aydınlatma ve fan
- * Seri haberleşme kartı ile kolay montaj

*Complies EN81-1 + A3 standards

*Compatible with synchronous and asynchronous motors

*With Arl 300 with control card

*Arkel A-drive & Fuji Frenic-lift & Ziehl-Abegg Zetadyn inverter options

*May work up to 1.6 m/s speed and 24 stops

*Group control up to 4 elevators

*Recovery with Ups (Easy Management)

*Early door opening and leveling

*Suitable for all types of automatic doors along with manual doors

*Double automatic door control for double entry elevators

*7 Segment & gray code & binary code indication outputs

*Elevator power cabinet lighting and fan

*Easy installation with serial communication card

ARKEL

mikrolift

mik-el
LIFT TECHNOLOGIES

HEDEFSAN
ELEVATOR TECHNOLOGIES

FUJI

SIEMENS

Schneider
Electric

LIFT
ELEVATOR TECHNOLOGIES
المصنعة والمركبات المصنعية





www.bizimlift.com

info@bizimlift.com ✉
bizimlift@gmail.com

bizimliftmarket 📘
bizimliftmarket 📷

Velibaba Mh. Mimar Sinan Cd. 📍
No.10 Pendik - İstanbul

0532 244 15 49 📱

0532 740 36 47

0532 503 18 00

0532 624 94 70

0216 627 01 06 📞

0850 302 6767

0216 627 01 09 📠

